

Varenummer: 204260M10100A1S
 Beskrivelse: E+G Justerfod
 GN 42-60-M10-100-A1-S
 Note: S Uden møtrik, udvendig sekskant i bunden

Mål

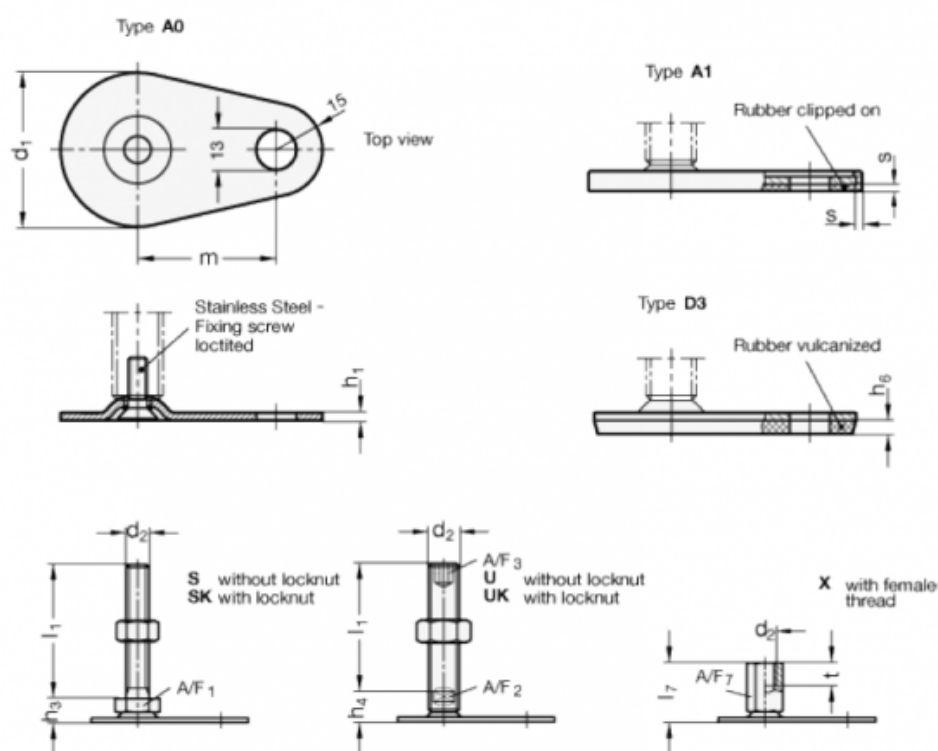

A/F1 = 17	s = 2
d1 = 60	
d2 = M10	
h1 = 2.5	
h3 = 11	
h6 =	
l1 = 100	
m = 50	